

DS-1273ZJ-135

Wall Mounting Bracket for Dome Camera

Features:

- Aluminum alloy material with surface spray treatment
- Design of cable entrance hole
- Better water proof design
- Convenient installation coordinating with adaptor cap

Dimension:

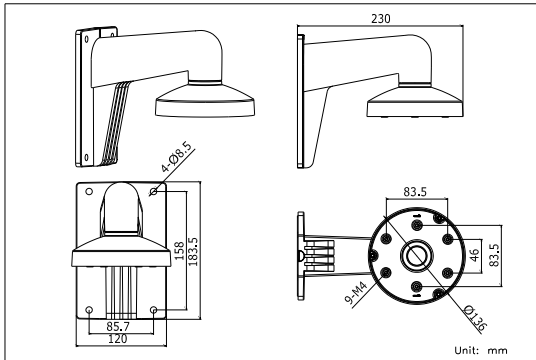

Order Model:

DS-1273ZJ-135



Parameter:

Model	DS-1273ZJ-135
Parameters	Wall Mounting Bracket for Dome Camera
Appearance	Hik White
Range of Application	Suitable for dome camera wall mounting
Material	Aluminum Alloy
Dimension	136×183.5×230mm
Weight	704g

Notice:

- The bracket should be installed on flat wall
- The wall must be capable of supporting over 3 times as much as the total weight of the camera and the mount.
- The maximum load capacity of the bracket is 4.5KG

Model Suitable:

DS-2CC52X1P(N)-VP, DS-2CC52X1P(N)-AVPIR2, DS-2CD2712F-I(S), DS-2CD2732F-I(S)

Installation Step:

- ① Choose appropriate wall to install the bracket and thread the cable

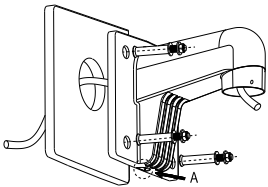

A: Cable entry hole

- ② Fix adaptor to bracket and thread the cable

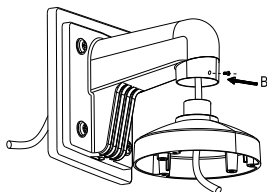

B: Fastening screw

- ③ Screw up and complete the fixation of adaptor

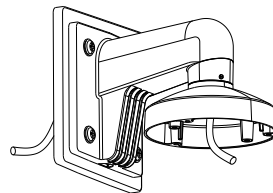

- ④ Take off lower dome and lining

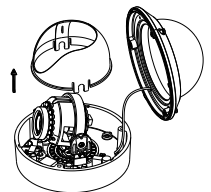

- ⑤ Install dome module to adaptor cap and fix with screw

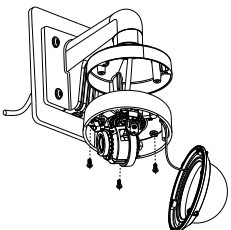

- ⑥ Install lining to inner module and adjust view of angle

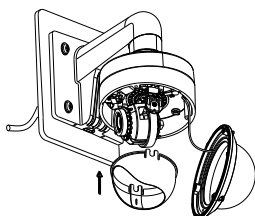

- ⑦ Install lower dome to module and screw up

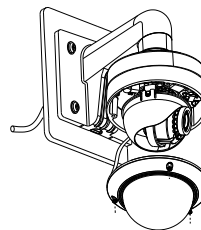

- ⑧ Installation complete

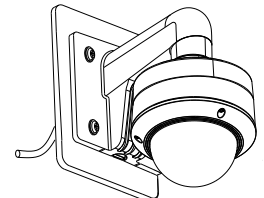

Note: The actual bracket may vary from the picture above.